













# R. C. Tronics Incorporated

2573 East Kercher Road  
Goshen, Indiana 46528  
Toll Free 1-866-457-7790

Phone 1-574-642-3857  
Fax 1-574-642-3858  
<http://www.rctronics.com>

RCT-02241-0\_04

## Southeastern Specialty Vehicles

 <b>ON</b> MODULE MASTER C-00021-02-0V2D	 <b>HIGH</b> LEFT DOME C-00022-10-0V2D  <b>LOW</b>	 <b>HIGH</b> RIGHT DOME C-00023-10-0V2D  <b>LOW</b>	 <b>ON</b> ACTION AREA C-00353-00-0V2D	 <b>ON</b> EXHAUST FAN C-00354-00-0V2D	 <b>ON</b> INVERTER C-00355-00-0V2D	NBL BLANK	NBL BLANK	 <b>ON</b> VACUUM C-00396-04-0V2D	NBL BLANK	 <b>FAN HIGH</b>  FAN MED.  FAN LOW C-00088-10-0V2D
--	---	--	--	--	---	-----------	-----------	---	-----------	--

FAC-02241-00001

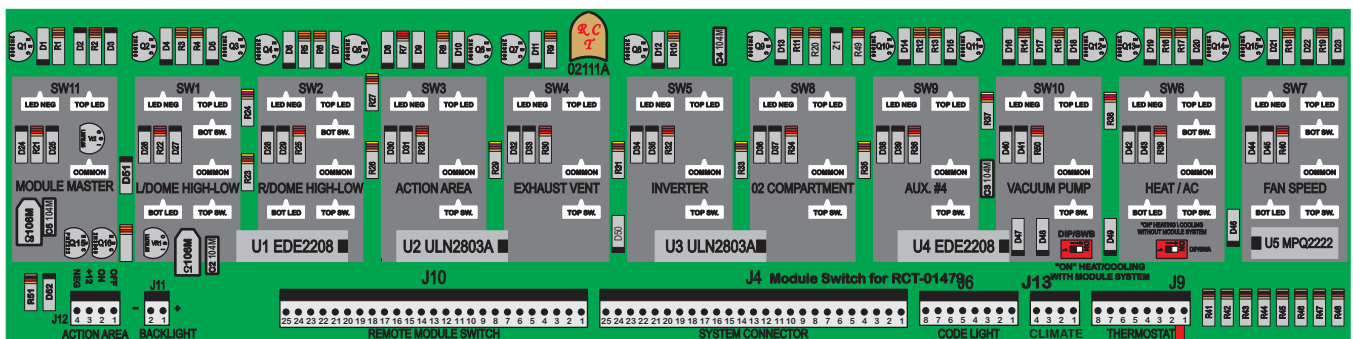

- J9-8 Battery Negative
- J9-7 Battery Positive
- J9-6 Fan Speed High
- J9-5 AC & Fan Speed Low
- J9-4 Heat & Fan Speed Low
- J9-3 Fan Speed Medium
- J9-2 Not Used
- J9-1 Not Used

