

R. C. Tronics, Incorporated

Specializing In Electronic Controls

**2573 East Kercher Road
Goshen, Indiana 46526
Toll Free 1-866-457-7790**

**Phone 1-574-642-3857
Fax 1-574-642-3858
<http://www.rctronics.com>**

**FAC-01408
Cal-Trans**



R. C. Tronics Incorporated

2573 East Kercher Road
Goshen, Indiana 46528
Toll Free 1-866-457-7790

Phone 1-574-642-3857
Fax 1-574-642-3858
<http://www.rctronics.com>

Cable Interface from RCT-00786, Bus Power Center to All Switch Centers.

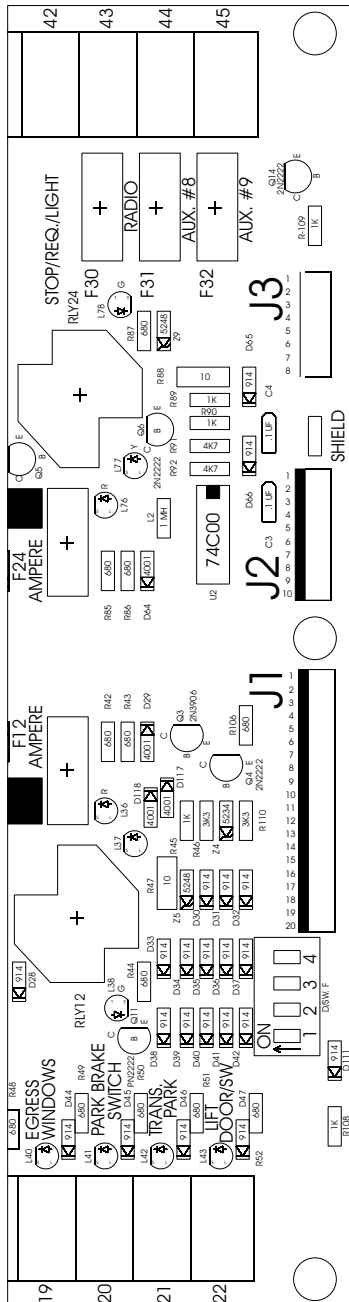

ADA Information PCB RCT-747 or RCT-1010

- Shift Lock Indicator. (Sink 1-Ampere Maximum)
- Transmission In Park. (Sink 1-Ampere Maximum)
- Lift Enable Indicator. (Sink 1-Ampere Maximum)
- Park Brake Set Indicator. (Sink 1-Ampere Maximum)
- Lift Door Open Indicator. (Sink 1-Ampere Maximum)
- Lift Switch On. (Sink 1-Ampere Maximum)
- Ignition (+12 VDC, Switched)
- Ignition (+12 VDC, Switched)

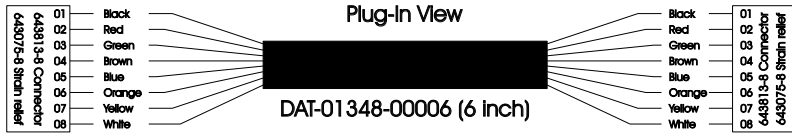

To Switch Center RCT-789 or RCT-948 / J2

- Aux. 5/B Switch (Sink)(To J3-5)
- Aux. 6/A Switch (Sink)(To J3-4)
- Aux. 6/B Switch (Sink)(To J3-3)
- Aux. 7/A Switch (Sink)(To J3-2)
- Aux. 7/B Switch (Sink)(To J3-1)
- Master Switch (Sink)
- Flasher Switch (Sink)
- Battery Negative
- Clearance Light Power (+12 VDC, Switched)(To J4-7)
- Ignition (+12 VDC, Switched)(To J4-7)

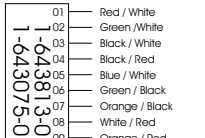

To Switch Center RCT-789 or RCT-948 / J1

- Ignition (+12 VDC Switched)(To J4-8)
- Buzzer Output (Sink)
- Entry Door Light (Sink)(To J4-6)
- Stop Request (Sink)(To J4-5)
- Rear Door Light (Sink)(To J4-4)
- Egress Windows (Sink)(To J4-3)
- ADA Stop Request (Sink)(To J4-2)
- Lift Door Light (Sink)(To J4-1)
- Aux. 5/A Switch (Sink)(To J3-6)
- Aux. 4/B Switch (Sink)(To Aux 4-T/SW)
- Aux. 4/A Switch (Sink)(To Aux 4-B/SW)
- Aux. 3/B Switch (Sink)(To Aux 3-T/SW)
- Aux. 3/A Switch (Sink)(To Aux 3-B/SW)
- Aux. 2/A Switch (Sink)(To Aux 2-T/SW)
- Aux. 2/B Switch (Sink)(To Aux 2-B/SW)
- Aux. 1 Switch (Sink)
- Lift Solenoid Switch (Sink)
- Dome Light Switch (Sink)
- Entry Door Close Switch (Sink)
- Entry Door Open Switch (Sink)

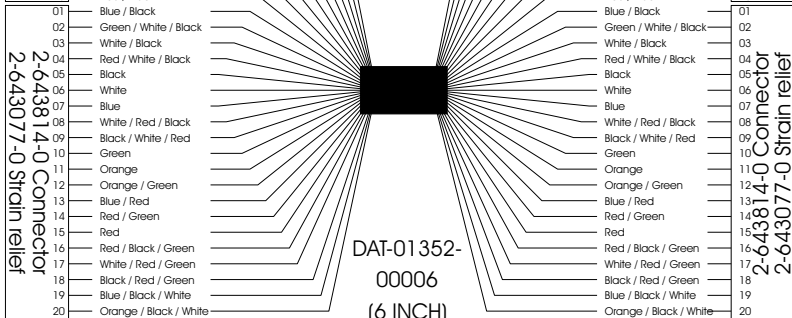

Use last three digits to order data cable.

Example, to order a 30 conductor 15 foot, 6 inch data cable.

DAT-01352-00-15-6

- D
A
T
0
1
3
5
2
0
0
0
6
- 1st three Letters = Data Cable
- 2nd five numbers = Print Number
- 3rd two numbers = Configuration
- 4th two numbers = Length In Feet
- 5th last digit = Length In Inches

R. C. Tronics Incorporated

2573 East Kercher Road
Goshen, Indiana 46528
Toll Free 1-866-457-7790

Phone 1-574-642-3857
Fax 1-574-642-3858
<http://www.rctronics.com>

RCT-01408-00000, Relays 4A, 4B, 5A & 5B

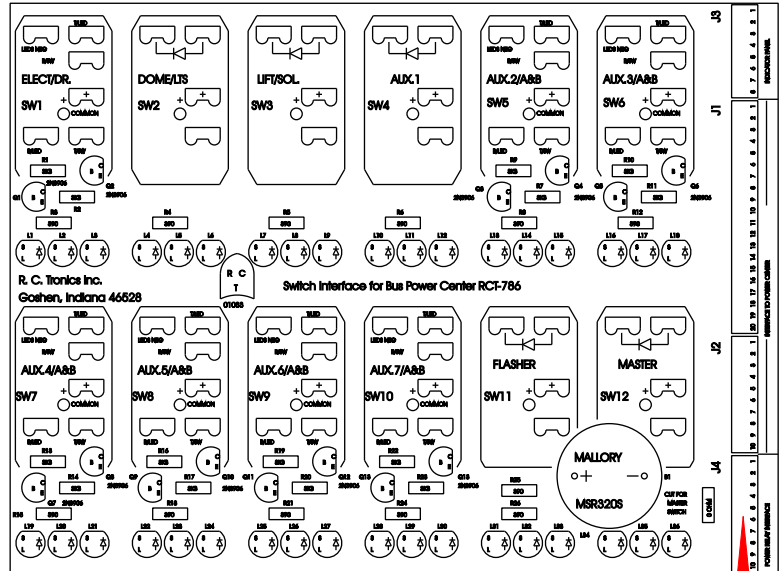
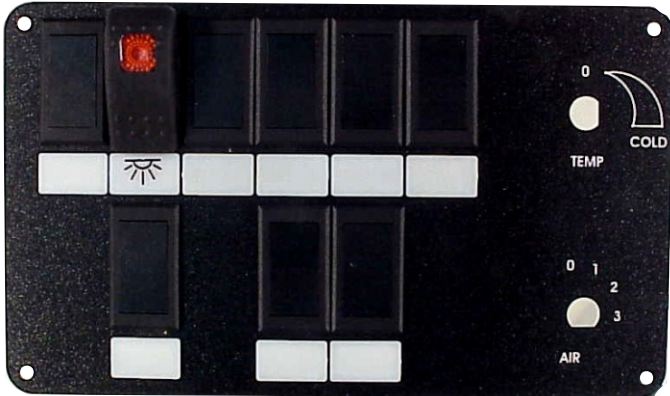

PCB-1083

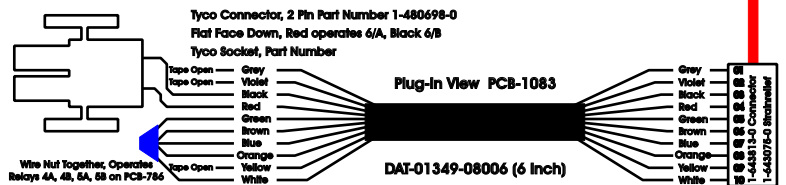

1- Faceplate, FAC-01241-00000, Material, Textures Coal Black / White, Part Number 842-422
1- S-01083

1 - 6 inch, Data Cable, DAT-01349-08006, connect to PCB-1083-J4

(Wire nut; green, brown, blue, orange & white. Operates relays 4A,4B, 5A & 5B.

Switch #01 Carling NBL Blank with L-00 Blank Legend.

Switch #02 Carling SB, Black, ON-OFF, V1D11XOB-AEB00-000-XRC1 with Legend L-182, "Interior Light."

Switch #03 Carling NBL Blank with L-00 Blank Legend.

Switch #04 Carling NBL Blank with L-00 Blank Legend.

Switch #05 Carling NBL Blank with L-00 Blank Legend.

Switch #06 Carling NBL Blank with L-00 Blank Legend.

Switch #07 Omitted

Switch #08 Carling NBL Blank with L-00 Blank Legend.

Switch #09 Omitted

Switch #10 Carling NBL Blank with L-00 Blank Legend.

Switch #11 Carling NBL Blank with L-00 Blank Legend.

Switch #12 Omitted

R. C. Tronics Incorporated

2573 East Kercher Road
Goshen, Indiana 46528
Toll Free 1-866-457-7790

Phone 1-574-642-3857
Fax 1-574-642-3858
<http://www.rctronics.com>

RCT-01408-00001, Relays 4A, 4B & 5B

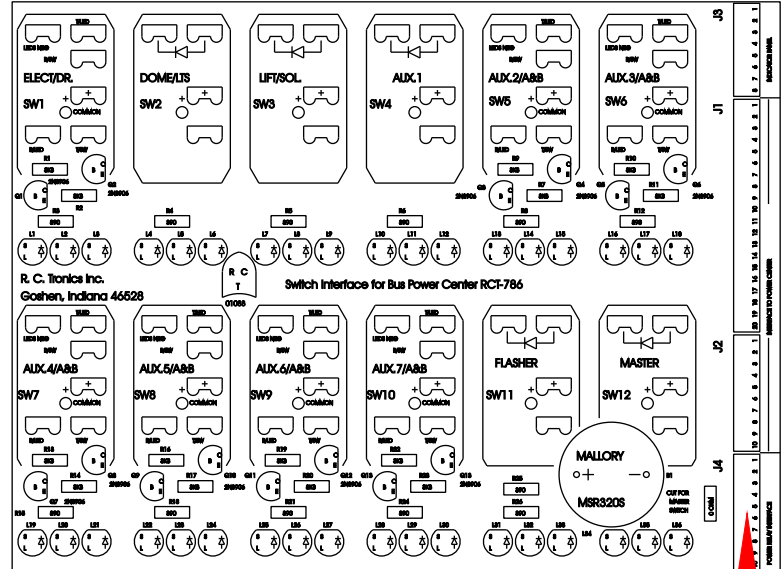
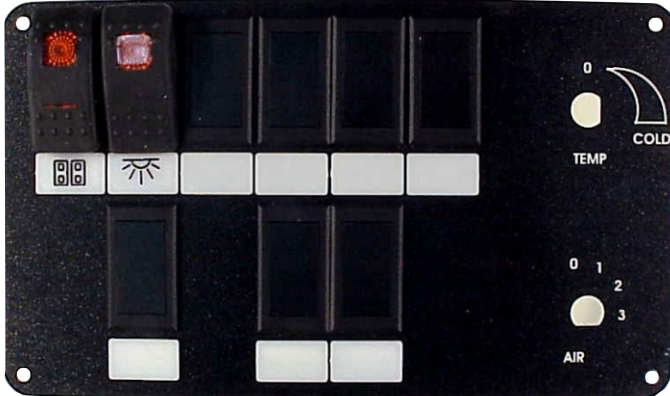

PCB-1083

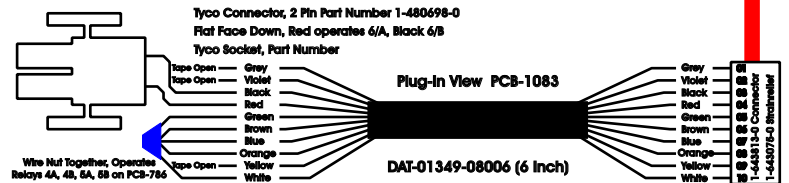

1- Faceplate, FAC-01241-00000, Material, Textures Coal Black / White, Part Number 842-422
1- S-01083

1 - 6 inch, Data Cable, DAT-01349-08006, connect to PCB-1083-J4

(Wire nut; green, brown, blue, orange & white. Operates relays 4A, 4B 5A & 5B.)

- Switch #01 Carling SB, (ON)-OFF-(ON), V8D1WXXB-AFB00-000-XAM1 with Legend L-181 "Entry Door".
- Switch #02 Carling SB, Black, ON-OFF, V1D11XOB-AEB00-000-XRC1 with Legend L-182, "Interior Light."
- Switch #03 Carling NBL Blank with L-00 Blank Legend.
- Switch #04 Carling NBL Blank with L-00 Blank Legend.
- Switch #05 Carling NBL Blank with L-00 Blank Legend.
- Switch #06 Carling NBL Blank with L-00 Blank Legend.
- Switch #07 Omitted
- Switch #08 Carling NBL Blank with L-00 Blank Legend.
- Switch #09 Omitted
- Switch #10 Carling NBL Blank with L-00 Blank Legend.
- Switch #11 Carling NBL Blank with L-00 Blank Legend.
- Switch #12 Omitted

R. C. Tronics Incorporated

2573 East Kercher Road
Goshen, Indiana 46528
Toll Free 1-866-457-7790

Phone 1-574-642-3857
Fax 1-574-642-3858
<http://www.rctronics.com>

RCT-01408-00002, Relays 4A, 4B, 5A & 5B

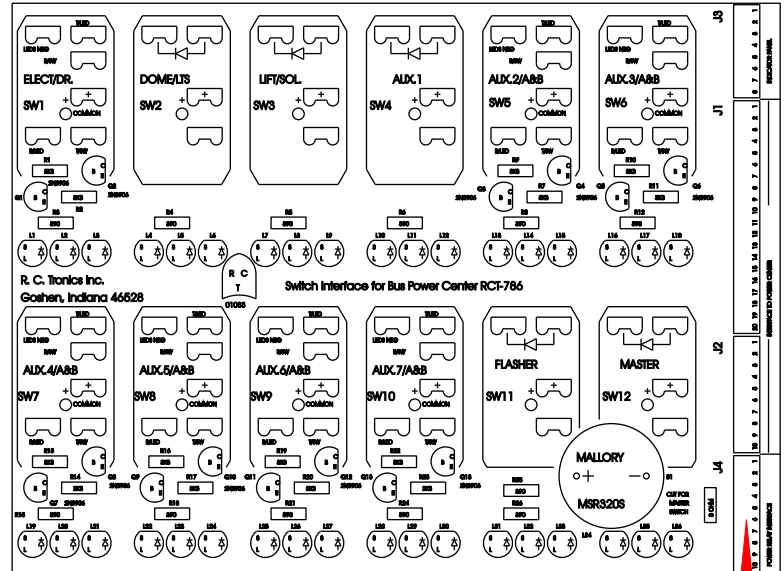
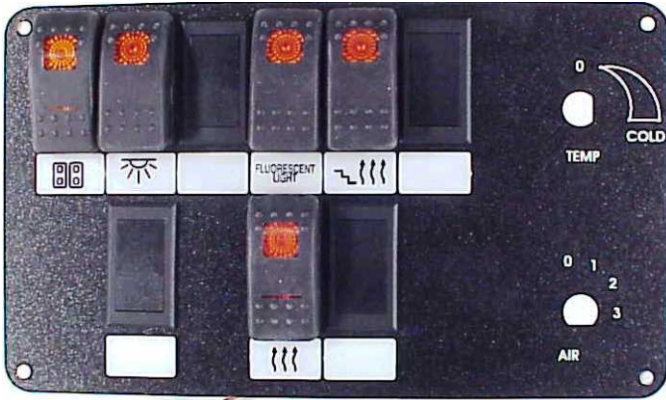

PCB-1083

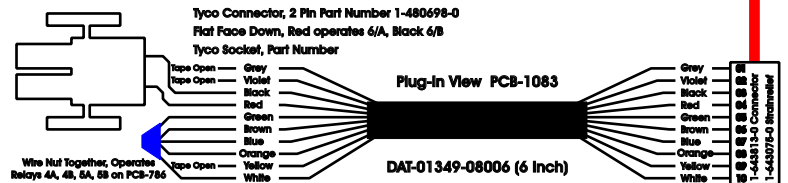

1- Faceplate, FAC-01241-00000, Material, Textures Coal Black / White, Part Number 842-422
1- S-01083

1 - 6 inch, Data Cable, DAT-01349-08006, connect to PCB-1083-J4

(Wire nut; green, brown, blue, orange & white. Operates relays 4A, 4B, 5A & 5B.)

- Switch #01 Carling SB, Black (ON)-OFF-(ON), V8D1-WXXB-AFB00-000-XAM1 with Legend L-181, "Entry Door."
- Switch #02 Carling SB, Black, ON-OFF, V1D11XOB-AEB00-000-XRC1 with Legend L-182, "Interior Light."
- Switch #03 Carling NBL Blank with L-00 Blank Legend.
- Switch #04 Carling SB, Black, ON-OFF, V1D11XOB-AEB00-000-XRC1 with Legend L-80 "Florcescent Lights".
- Switch #05 Carling SB, ON-OFF, V1D11XOB-AEB00-000-XRC1 with Legend L-186 "Heated Step".
- Switch #06 Carling NBL Blank with L-00 Blank Legend.
- Switch #07 Omitted
- Switch #08 Carling NBL Blank with L-00 Blank Legend.
- Switch #09 Omitted
- Switch #10 Carling SB, ON-OFF-ON, V6D1WXXB-AFB-00-000-XRC1 with Legend L-187 "2nd Heated Step".
- Switch #11 Carling NBL Blank with L-00 Blank Legend
- Switch #12 Omitted.

R. C. Tronics Incorporated

2573 East Kercher Road
Goshen, Indiana 46528
Toll Free 1-866-457-7790

Phone 1-574-642-3857
Fax 1-574-642-3858
<http://www.rctronics.com>

RCT-01408-00003, Relays 4A, 4B, 5A & 5B

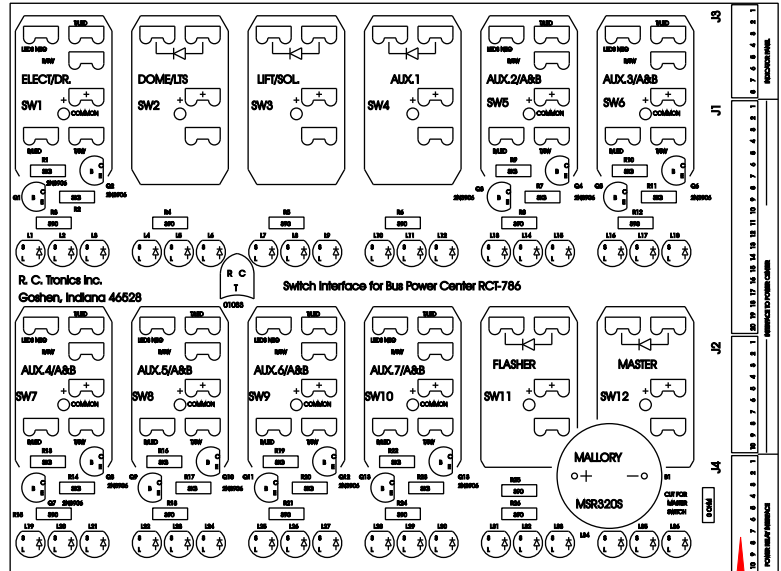
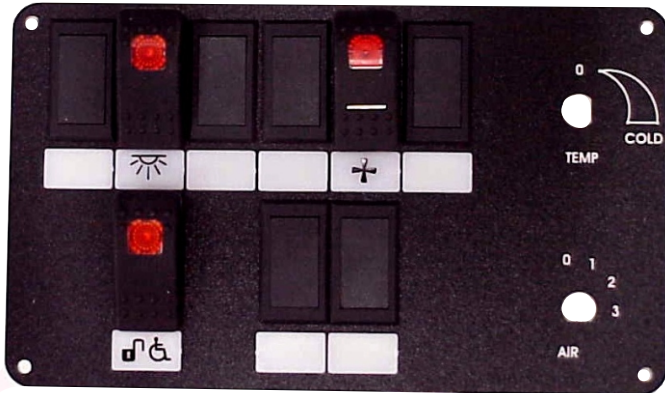

PCB-1083

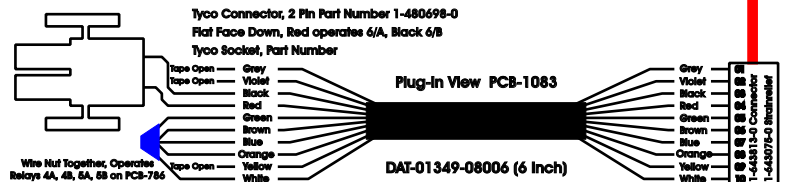

1- Faceplate, FAC-01241-00000, Material, Textures Coal Black / White, Part Number 842-422

1- S-01083

1 - 6 inch, Data Cable, DAT-01349-08006, connect to PCB-1083-J4

(Wire nut; green, brown, blue, orange & white. Operates relays 4A, 4B, 5A & 5B.)

Switch #01 Carling NBL Blank with L-00 Blank Legend.

Switch #02 Carling SB, Black, ON-OFF, V1D11XOB-AEB00-000-XRC1 with Legend L-182, "Interior Light."

Switch #03 Carling NBL Blank with L-00 Blank Legend.

Switch #04 Carling NBL Blank with L-00 Blank Legend.

Switch #05 Carling SB, ON-OFF-ON, V6D1WXXB-AFB-00-000-XRC1 with Legend L-185 "Exhaust Fan".

Switch #06 Carling NBL Blank with L-00 Blank Legend.

Switch #07 Omitted

Switch #08 Carling SB, Black, ON-OFF, V1D11XOB-AEB00-000-XRC1 with Legend L-183 "Lift Interlock".

Switch #09 Omitted

Switch #10 Carling NBL Blank with L-00 Blank Legend.

Switch #11 Carling NBL Blank with L-00 Blank Legend.

Switch #12 Omitted

R. C. Tronics Incorporated

2573 East Kercher Road
Goshen, Indiana 46528
Toll Free 1-866-457-7790

Phone 1-574-642-3857
Fax 1-574-642-3858
<http://www.rctronics.com>

RCT-01408-00004, Relays 4A, 4B, 5A & 5B

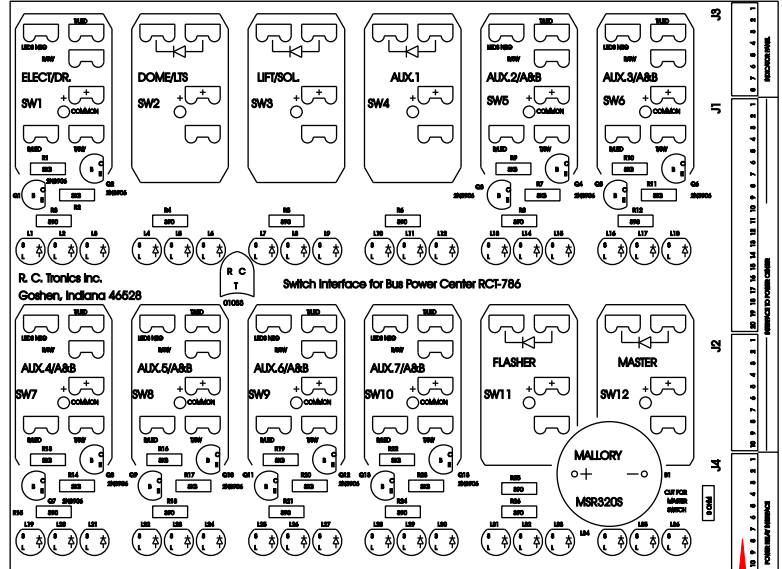
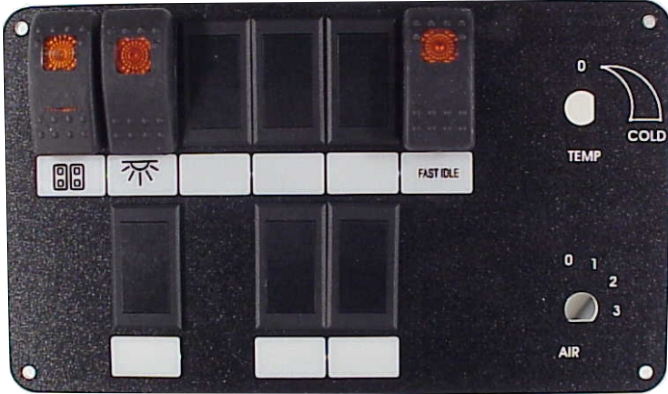

PCB-1083

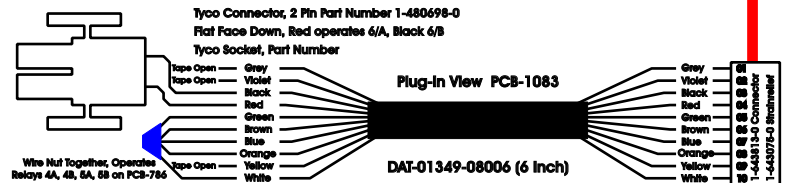

1- Faceplate, FAC-01241-00000, Material, Textures Coal Black / White, Part Number 842-422
1- S-01083

1 - 6 inch, Data Cable, DAT-01349-08006, connect to PCB-1083-J4

(Wire nut; green, brown, blue, orange & white. Operates relays 4A, 4B, 5A & 5B.)

Switch #01 Carling SB, Black (ON)-OFF-(ON), V8D1-WXXB-AFB00-000-XAM1 with Legend L-181, "Entry Door."

Switch #02 Carling SB, Black, ON-OFF, V1D11XOB-AEB00-000-XRC1 with Legend L-182, "Interior Light."

Switch #03 Carling NBL Blank with L-00 Blank Legend.

Switch #04 Carling NBL Blank with L-00 Blank Legend.

Switch #05 Carling NBL Blank with L-00 Blank Legend

Switch #06 Carling SB, Black, ON-OFF, V1D11XOB-AEB00-000-XRC1 with Legend L-6, "Fast Idle".

Switch #07 Omitted

Switch #08 Carling NBL Blank with L-00 Blank Legend.

Switch #09 Omitted

Switch #10 Carling NBL Blank with L-00 Blank Legend

Switch #11 Carling NBL Blank with L-00 Blank Legend

Switch #12 Omitted.

R. C. Tronics Incorporated

2573 East Kercher Road
Goshen, Indiana 46528
Toll Free 1-866-457-7790

Phone 1-574-642-3857
Fax 1-574-642-3858
<http://www.rctronics.com>

RCT-01408-00005, Relays 4A, 4B, 5A & 5B

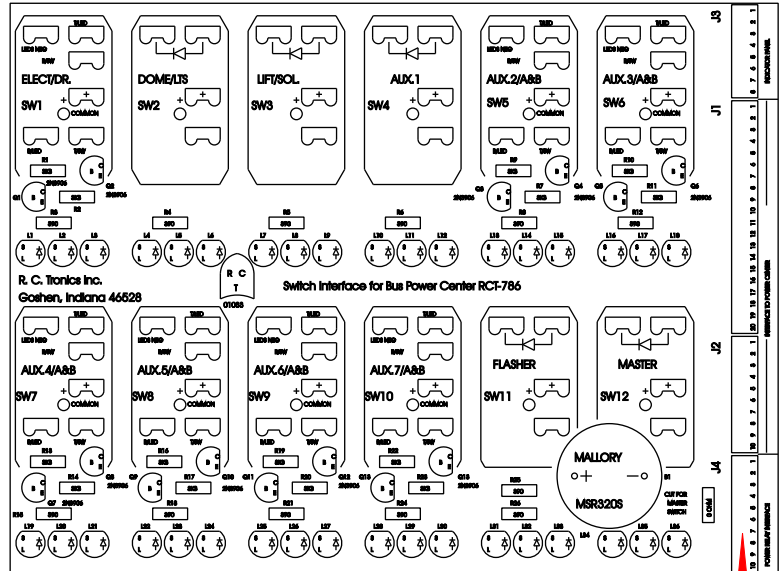
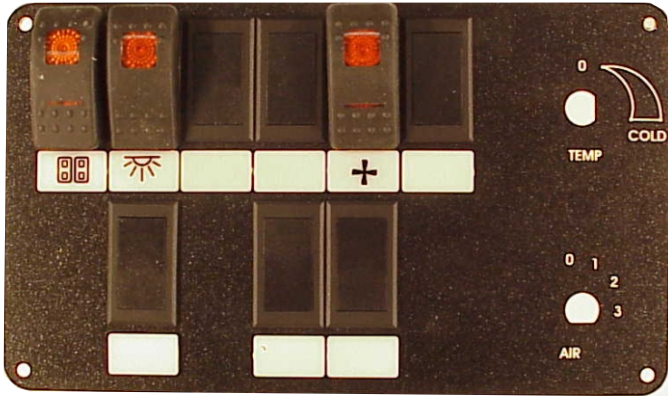

PCB-1083

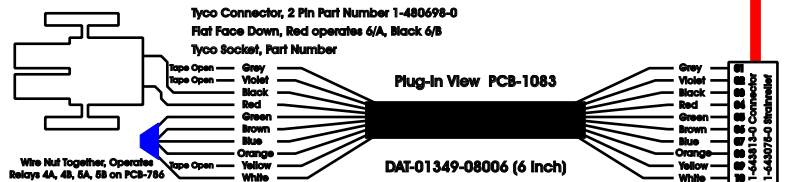

1- Faceplate, FAC-01241-00000, Material, Textures Coal Black / White, Part Number 842-422
1- S-01083

1 - 6 inch, Data Cable, DAT-01349-08006, connect to PCB-1083-J4

(Wire nut; green, brown, blue, orange & white. Operates relays 4A, 4B, 5A & 5B.)

- Switch #01 Carling SB, Black (ON)-OFF-(ON), V8D1-WXXB-AFB00-000-XAM1 with Legend L-181, "Entry Door."
- Switch #02 Carling SB, Black, ON-OFF, V1D11XOB-AEB00-000-XRC1 with Legend L-182, "Interior Light."
- Switch #03 Carling NBL Blank with L-00 Blank Legend.
- Switch #04 Carling NBL Blank with L-00 Blank Legend.
- Switch #05 Carling SB, Black, ON-OFF-ON, V6D1WXXB-AFB00-000-XRC1 with Legend L-185, "Defroster Fan."
- Switch #06 Carling NBL Blank with L-00 Blank Legend
- Switch #07 Omitted
- Switch #08 Carling NBL Blank with L-00 Blank Legend.
- Switch #09 Omitted
- Switch #10 Carling NBL Blank with L-00 Blank Legend
- Switch #11 Carling NBL Blank with L-00 Blank Legend
- Switch #12 Omitted.

R. C. Tronics Incorporated

2573 East Kercher Road
Goshen, Indiana 46528
Toll Free 1-866-457-7790

Phone 1-574-642-3857
Fax 1-574-642-3858
<http://www.rctronics.com>

RCT-01408-00007, Relays 4A, 4B, 5A & 5B

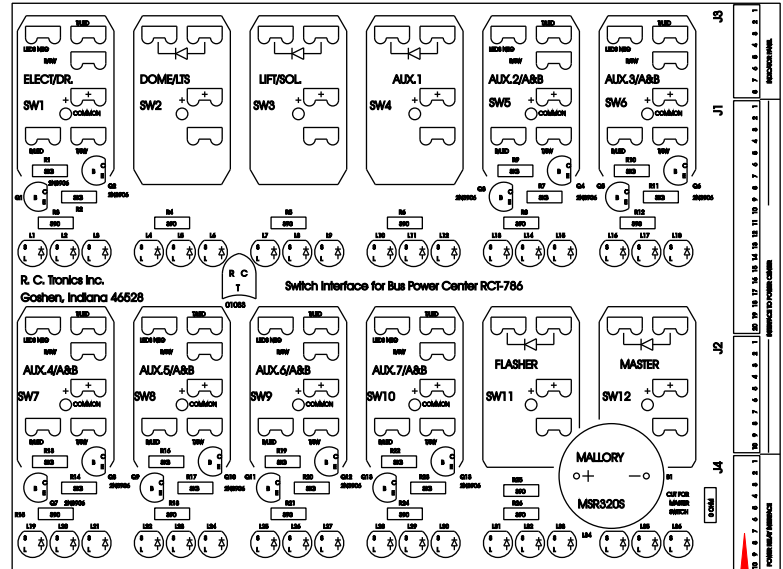
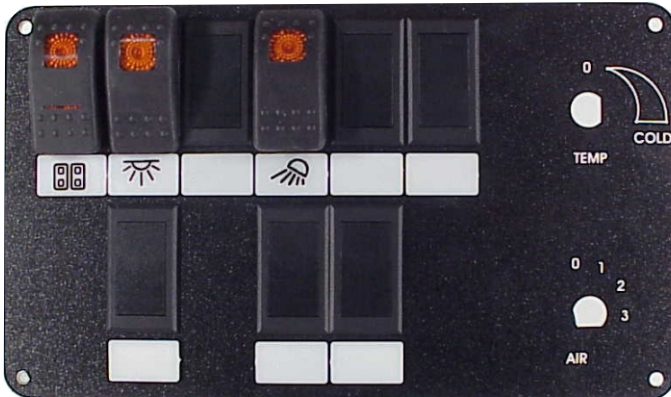

PCB-1083

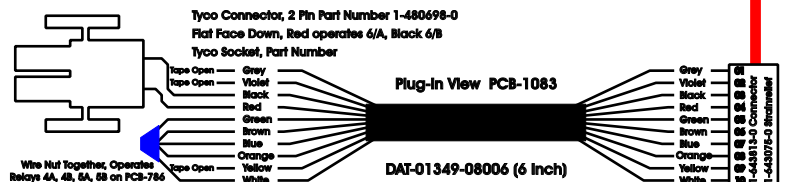

1- Faceplate, FAC-01241-00000, Material, Textures Coal Black / White, Part Number 842-422

1- S-01083

1 - 6 inch, Data Cable, DAT-01349-08006, connect to PCB-1083-J4

(Wire nut; green, brown, blue, orange & white. Operates relays 4A, 4B, 5A & 5B.)

Switch #01 Carling SB, Black (ON)-OFF-(ON), V8D1-WXXB-AFB00-000-XAM1 with Legend L-181, "Entry Door."

Switch #02 Carling SB, Black, ON-OFF, V1D11XOB-AEB00-000-XRC1 with Legend L-182, "Interior Light."

Switch #03 Carling NBL Blank with L-00 Blank Legend.

Switch #04 Carling SB, Black, ON-OFF, V1D11XOB-AEB00-000-XRC1 with Legend L-184, "Reading Light."

Switch #05 Carling NBL Blank with L-00 Blank Legend

Switch #06 Carling NBL Blank with L-00 Blank Legend

Switch #07 Omitted

Switch #08 Carling NBL Blank with L-00 Blank Legend.

Switch #09 Omitted

Switch #10 Carling NBL Blank with L-00 Blank Legend

Switch #11 Carling NBL Blank with L-00 Blank Legend

Switch #12 Omitted.

R. C. Tronics Incorporated

2573 East Kercher Road
Goshen, Indiana 46528
Toll Free 1-866-457-7790

Phone 1-574-642-3857
Fax 1-574-642-3858
<http://www.rctronics.com>

RCT-01408-00008, Relays 4A, 4B, 5A & 5B

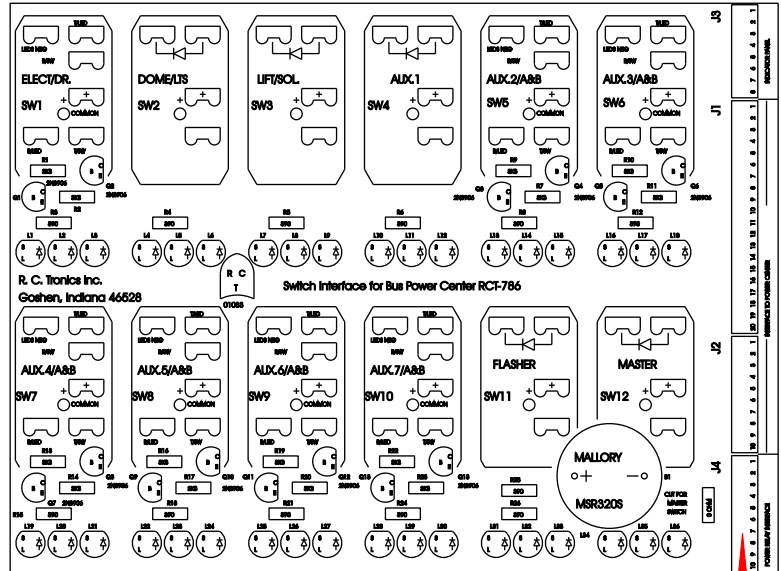
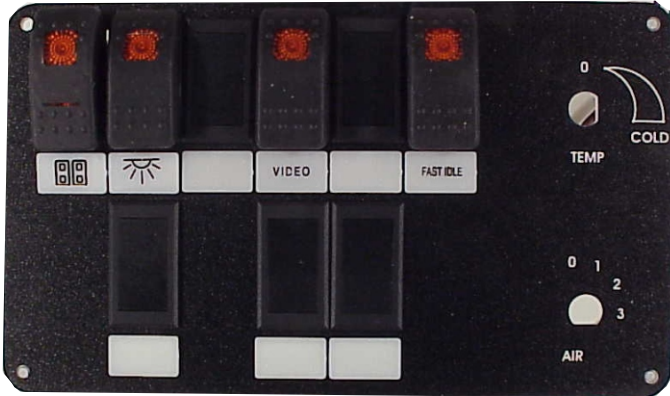

PCB-1083

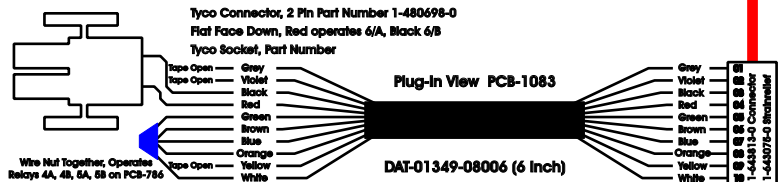

1- Faceplate, FAC-01241-00000, Material, Textures Coal Black / White, Part Number 842-422
1- S-01083

1 - 6 inch, Data Cable, DAT-01349-08006, connect to PCB-1083-J4

(Wire nut; green, brown, blue, orange & white. Operates relays 4A, 4B, 5A & 5B.)

Switch #01 Carling SB, Black (ON)-OFF-(ON), V8D1-WXXB-AFB00-000-XAM1 with Legend L-181, "Entry Door."

Switch #02 Carling SB, Black, ON-OFF, V1D11XOB-AEB00-000-XRC1 with Legend L-182, "Interior Light."

Switch #03 Carling NBL Blank with L-00 Blank Legend.

Switch #04 Carling SB, Black, ON-OFF, V1D11XOB-AEB00-000-XRC1 with Legend L-149, "Video."

Switch #05 Carling NBL Blank with L-00 Blank Legend

Switch #06 Carling SB, Black, ON-OFF, V1D11XOB-AEB00-000-XRC1 with Legend L-6, "Fast Idle."

Switch #07 Omitted

Switch #08 Carling NBL Blank with L-00 Blank Legend.

Switch #09 Omitted

Switch #10 Carling NBL Blank with L-00 Blank Legend

Switch #11 Carling NBL Blank with L-00 Blank Legend

Switch #12 Omitted.

R. C. Tronics Incorporated

2573 East Kercher Road
Goshen, Indiana 46528
Toll Free 1-866-457-7790

Phone 1-574-642-3857
Fax 1-574-642-3858
<http://www.rctronics.com>

RCT-01408-00009, Relays 4A, 4B, 5A & 5B

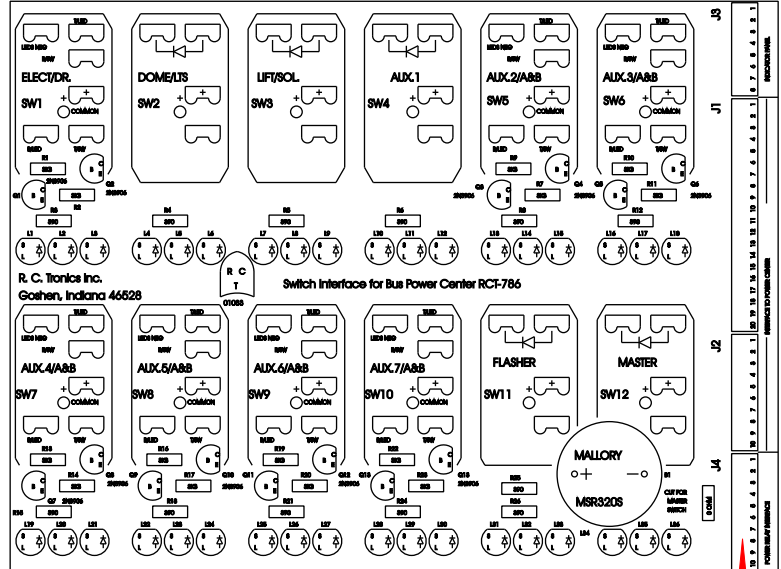
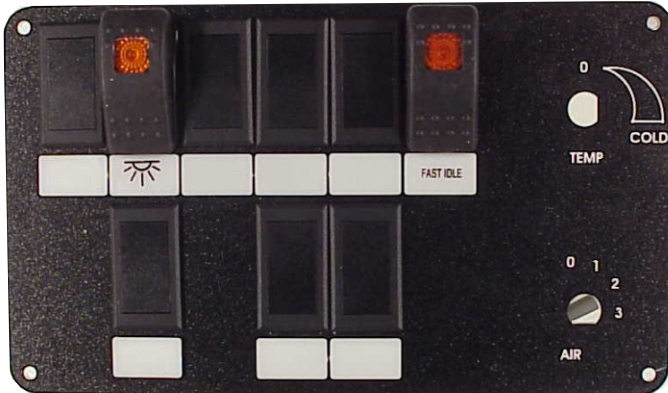

PCB-1083

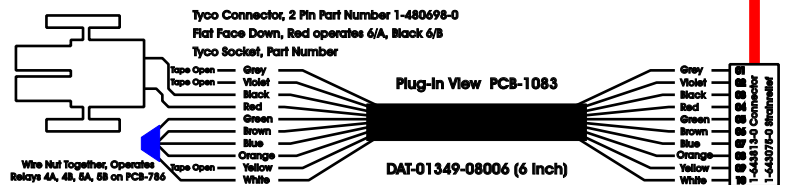

1- Faceplate, FAC-01241-00000, Material, Textures Coal Black / White, Part Number 842-422
1- S-01083

1 - 6 inch, Data Cable, DAT-01349-08006, connect to PCB-1083-J4

(Wire nut; green, brown, blue, orange & white. Operates relays 4A, 4B, 5A & 5B.)

Switch #01 Carling NBL Blank with L-00 Blank Legend.

Switch #02 Carling SB, Black, ON-OFF, V1D11XOB-AEB00-000-XRC1 with Legend L-182, "Interior Light."

Switch #03 Carling NBL Blank with L-00 Blank Legend.

Switch #04 Carling NBL Blank with L-00 Blank Legend.

Switch #05 Carling NBL Blank with L-00 Blank Legend

Switch #06 Carling SB, Black, ON-OFF, V1D11XOB-AEB00-000-XRC1 with Legend L-6, "Fast Idle".

Switch #07 Omitted

Switch #08 Carling NBL Blank with L-00 Blank Legend.

Switch #09 Omitted

Switch #10 Carling NBL Blank with L-00 Blank Legend

Switch #11 Carling NBL Blank with L-00 Blank Legend

Switch #12 Omitted.

R. C. Tronics Incorporated

2573 East Kercher Road
Goshen, Indiana 46528
Toll Free 1-866-457-7790

Phone 1-574-642-3857
Fax 1-574-642-3858
<http://www.rctronics.com>

RCT-01408-00010, Relays 4A, 4B, 5A & 5B

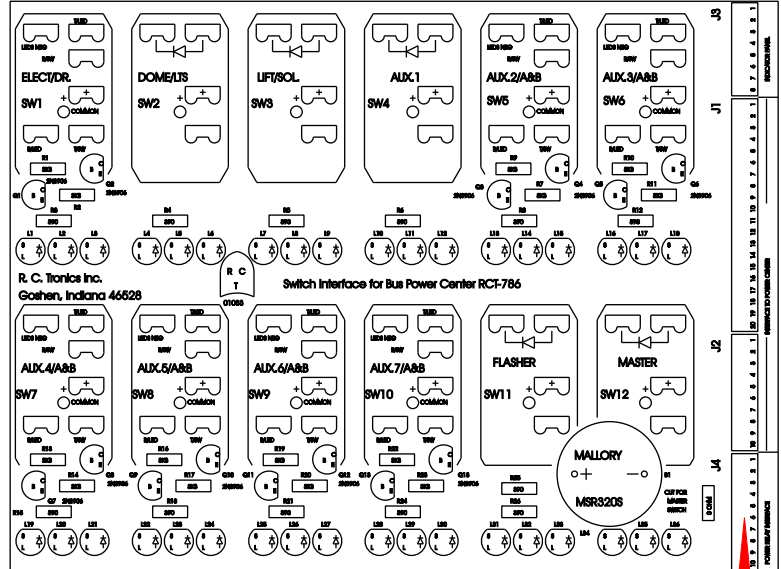
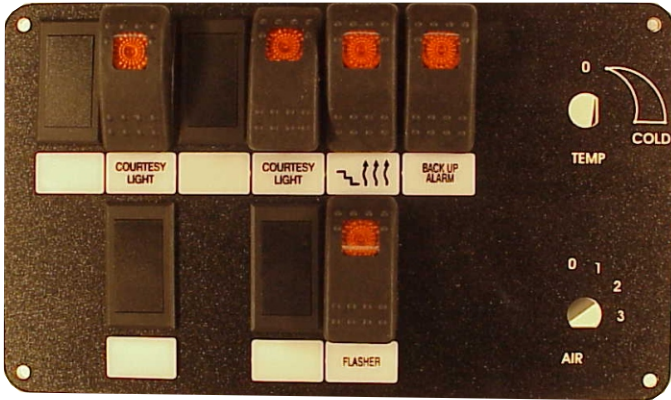

PCB-1083

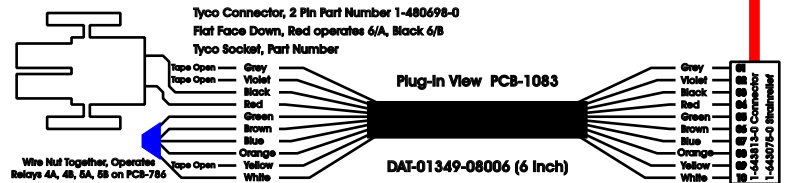

1- Faceplate, FAC-01241-00000, Material, Textures Coal Black / White, Part Number 842-422
1- S-01083

1 - 6 inch, Data Cable, DAT-01349-08006, connect to PCB-1083-J4

(Wire nut; green, brown, blue, orange & white. Operates relays 4A, 4B, 5A & 5B.)

Switch #01 Carling NBL Blank with L-00 Blank Legend.

Switch #02 Carling SB, Black, ON-OFF, V1D11XOB-AEB00-000-XRC1 with Legend L-202, "Courtesy Light."

Switch #03 Carling NBL Blank with L-00 Blank Legend.

Switch #04 Carling SB, Black, ON-OFF, V1D11XOB-AEB00-000-XRC1 with Legend L-202, "Courtesy Light."

Switch #05 Carling SB, Black, ON-OFF, V1D11XOB-AEB00-000-XRC1 with Legend L-186 "Heated Step".

Switch #06 Carling SB, Black, ON-OFF, V1D11XOB-AEB00-000-XRC1 with Legend L-42 "Back Up Alarm".

Switch #07 Omitted

Switch #08 Carling NBL Blank with L-00 Blank Legend.

Switch #09 Omitted

Switch #10 Carling NBL Blank with L-00 Blank Legend

Switch #11 Carling SB, ON-OFF, V1D11XOB-AEB00-000-XRC1 with Legend L-46 "Flasher".

Switch #12 Omitted.

R. C. Tronics Incorporated

2573 East Kercher Road
Goshen, Indiana 46528
Toll Free 1-866-457-7790

Phone 1-574-642-3857
Fax 1-574-642-3858
<http://www.rctronics.com>

RCT-01408-00011, Relays 4A, 4B, 5A & 5B

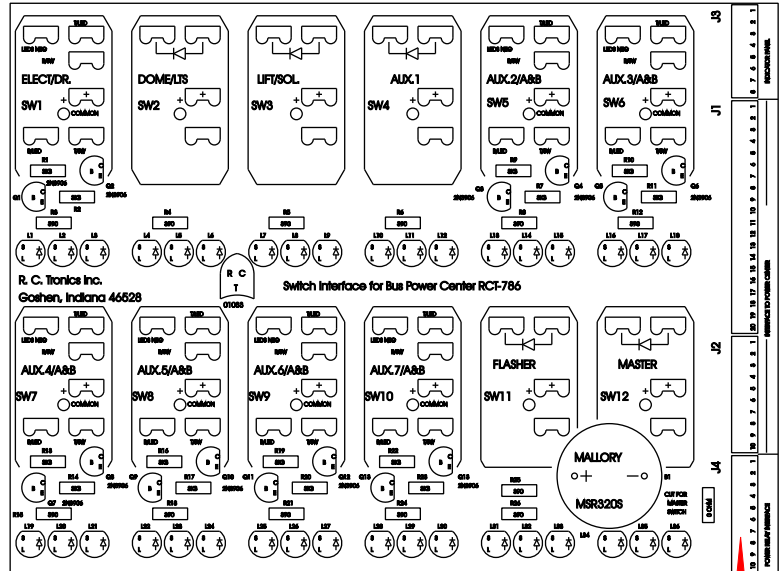
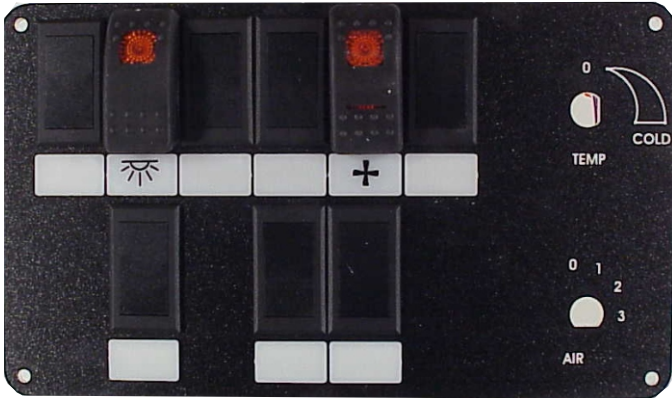

PCB-1083

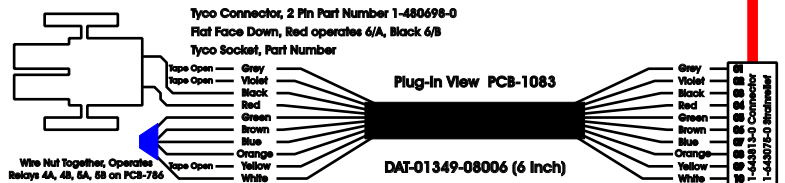

1- Faceplate, FAC-01241-00000, Material, Textures Coal Black / White, Part Number 842-422
1- S-01083

1 - 6 inch, Data Cable, DAT-01349-08006, connect to PCB-1083-J4

(Wire nut; green, brown, blue, orange & white. Operates relays 4A, 4B, 5A & 5B.)

Switch #01 Carling NBL Blank with L-00 Blank Legend.

Switch #02 Carling SB, Black, ON-OFF, V1D11XOB-AEB00-000-XRC1 with Legend L-182, "Interior Light."

Switch #03 Carling NBL Blank with L-00 Blank Legend.

Switch #04 Carling NBL Blank with L-00 Blank Legend.

Switch #05 Carling SB, ON-OFF-ON, V6D1WXXB-AFB-00-000-XRC1 with Legend L-185 "Exhaust Fan".

Switch #06 Carling NBL Blank with L-00 Blank Legend.

Switch #07 Omitted

Switch #08 Carling NBL Blank with L-00 Blank Legend.

Switch #09 Omitted

Switch #10 Carling NBL Blank with L-00 Blank Legend.

Switch #11 Carling NBL Blank with L-00 Blank Legend.

Switch #12 Omitted

R. C. Tronics Incorporated

2573 East Kercher Road
Goshen, Indiana 46528
Toll Free 1-866-457-7790

Phone 1-574-642-3857
Fax 1-574-642-3858
<http://www.rctronics.com>

RCT-01408-00012, Relays 4A, 4B, 5A & 5B

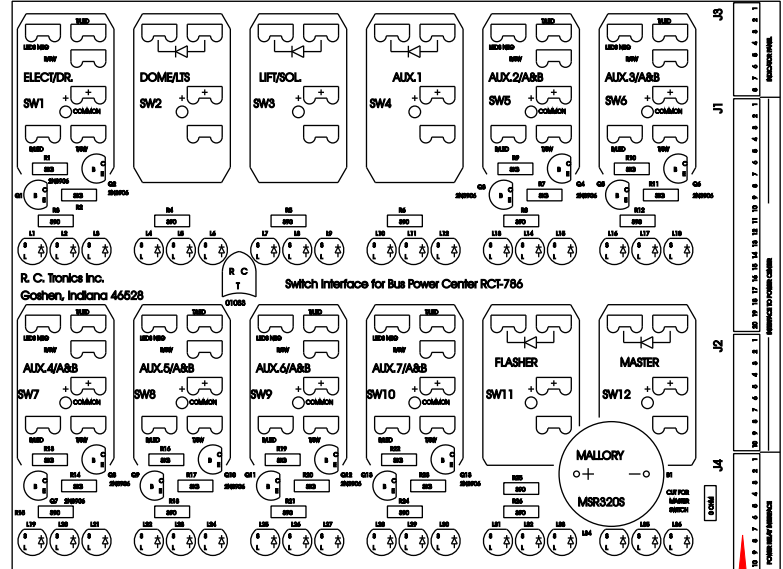
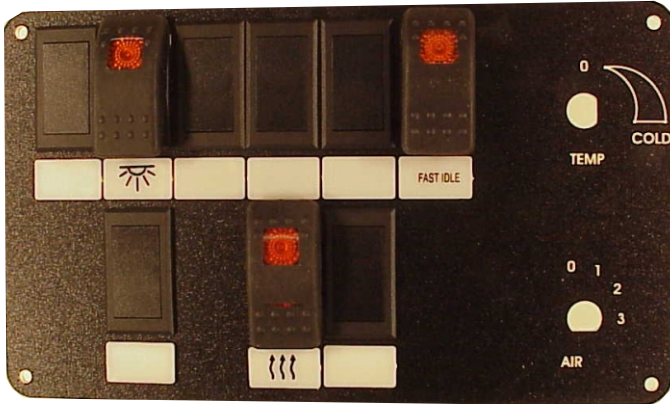

PCB-1083

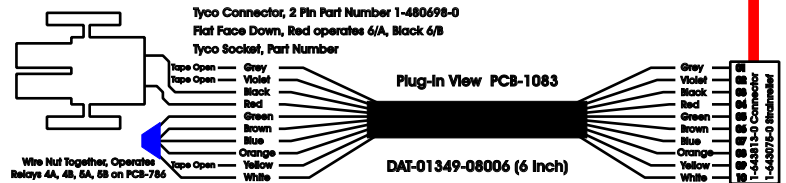

1- Faceplate, FAC-01241-00000, Material, Textures Coal Black / White, Part Number 842-422
1- S-01083

1 - 6 inch, Data Cable, DAT-01349-08006, connect to PCB-1083-J4

(Wire nut; green, brown, blue, orange & white. Operates relays 4A, 4B, 5A & 5B.)

Switch #01 Carling NBL Blank with L-00 Blank Legend.

Switch #02 Carling SB, Black, ON-OFF, V1D11XOB-AEB00-000-XRC1 with Legend L-182, "Interior Light."

Switch #03 Carling NBL Blank with L-00 Blank Legend.

Switch #04 Carling NBL Blank with L-00 Blank Legend.

Switch #05 Carling NBL Blank with L-00 Blank Legend.

Switch #06 Carling SB, Black, ON-OFF, V1D11XOB-AEB00-000-XRC1 with Legend L-6, "Fast Idle."

Switch #07 Omitted

Switch #08 Carling NBL Blank with L-00 Blank Legend.

Switch #09 Omitted

Switch #10 Carling SB, ON-OFF-ON, V6D1WXXB-AFB-00-000-XRC1 with Legend L-187 "2nd Rear Heater".

Switch #11 Carling NBL Blank with L-00 Blank Legend.

Switch #12 Omitted

R. C. Tronics Incorporated

2573 East Kercher Road
Goshen, Indiana 46528
Toll Free 1-866-457-7790

Phone 1-574-642-3857
Fax 1-574-642-3858
<http://www.rctronics.com>

RCT-01408-00013, Relays 4A, 4B, 5A & 5B

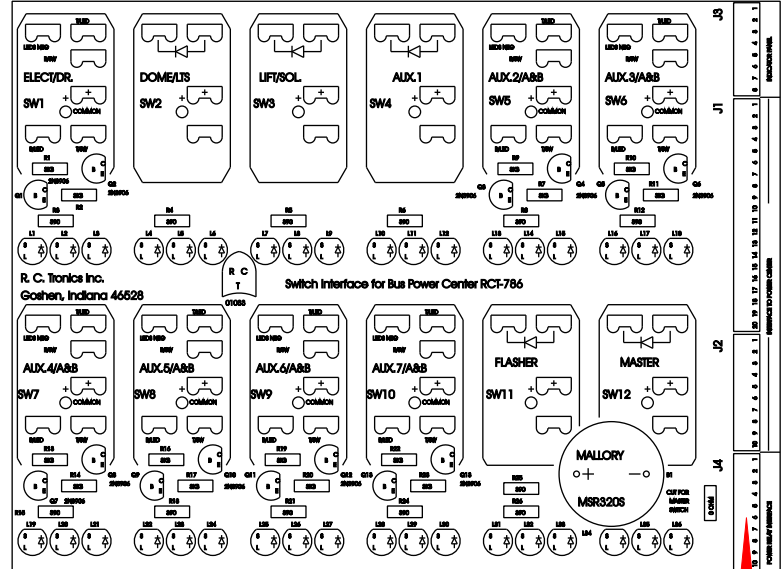
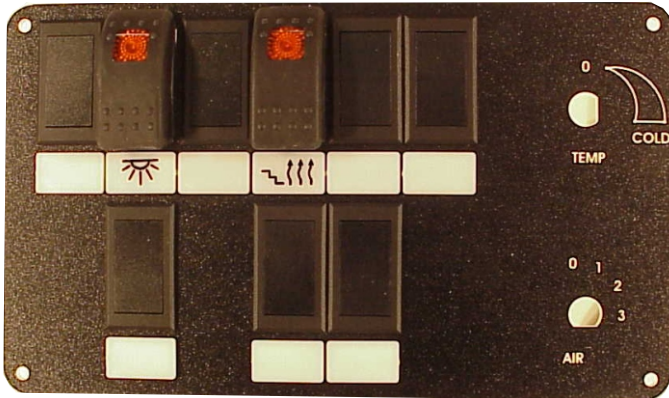

PCB-1083

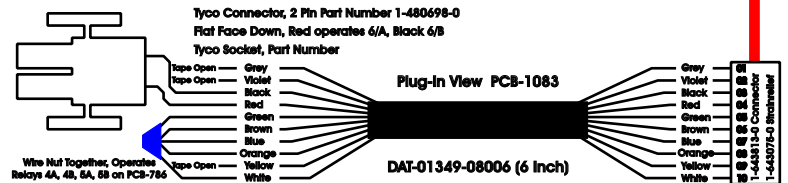

1- Faceplate, FAC-01241-00000, Material, Textures Coal Black / White, Part Number 842-422
1- S-01083

1 - 6 inch, Data Cable, DAT-01349-08006, connect to PCB-1083-J4

(Wire nut; green, brown, blue, orange & white. Operates relays 4A, 4B, 5A & 5B.)

Switch #01 Carling NBL Blank with L-00 Blank Legend

Switch #02 Carling SB, Black, ON-OFF, V1D11XOB-AEB00-000-XRC1 with Legend L-182, "Interior Light."

Switch #03 Carling NBL Blank with L-00 Blank Legend.

Switch #04 Carling SB, Black, ON-OFF, V1D11XOB-AEB00-000-XRC1 with Legend L-186 "Heated Step".

Switch #05 Carling NBL Blank with L-00 Blank Legend

Switch #06 Carling NBL Blank with L-00 Blank Legend.

Switch #07 Omitted

Switch #08 Carling NBL Blank with L-00 Blank Legend.

Switch #09 Omitted

Switch #10 Carling NBL Blank with L-00 Blank Legend

Switch #11 Carling NBL Blank with L-00 Blank Legend

Switch #12 Omitted.

R. C. Tronics Incorporated

2573 East Kercher Road
Goshen, Indiana 46528
Toll Free 1-866-457-7790

Phone 1-574-642-3857
Fax 1-574-642-3858
<http://www.rctronics.com>

RCT-01408-00014, Relays 4A, 4B, 5A & 5B

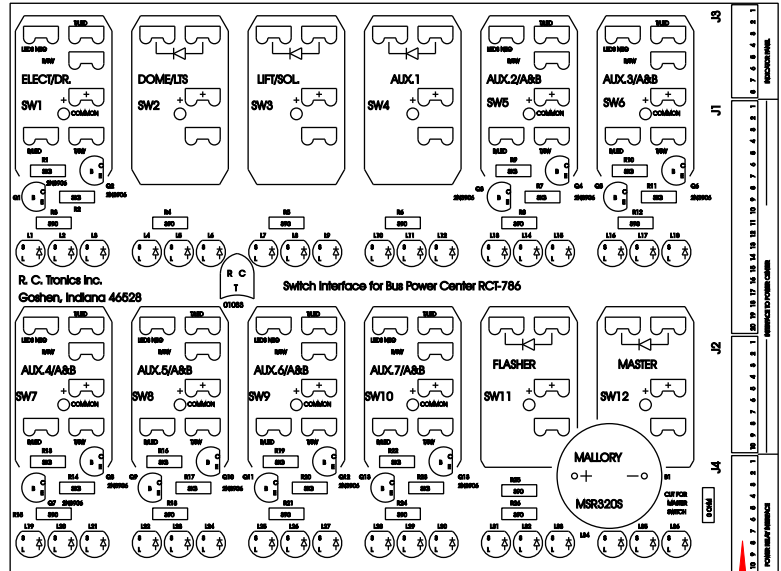
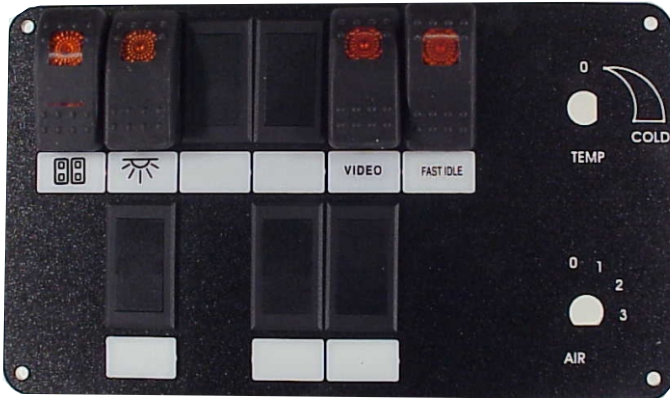

PCB-1083

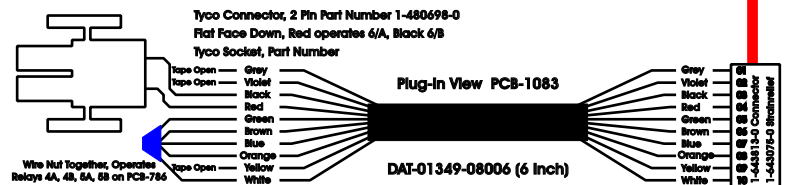

1- Faceplate, FAC-01241-00000, Material, Textures Coal Black / White, Part Number 842-422
1- S-01083

1 - 6 inch, Data Cable, DAT-01349-08006, connect to PCB-1083-J4

(Wire nut; green, brown, blue, orange & white. Operates relays 4A, 4B, 5A & 5B.)

Switch #01 Carling SB, Black (ON)-OFF-(ON), V8D1-WXXB-AFB00-000-XAM1 with Legend L-181, "Entry Door."

Switch #02 Carling SB, Black, ON-OFF, V1D11XOB-AEB00-000-XRC1 with Legend L-182, "Interior Light."

Switch #03 Carling NBL Blank with L-00 Blank Legend.

Switch #04 Carling NBL Blank with L-00 Blank Legend.

Switch #05 Carling SB, Black, ON-OFF, V1D11XOB-AEB00-000-XRC1 with Legend L-149, "Video".

Switch #06 Carling SB, Black, ON-OFF, V1D11XOB-AEB00-000-XRC1 with Legend L-6, "Fast Idle".

Switch #07 Omitted

Switch #08 Carling NBL Blank with L-00 Blank Legend.

Switch #09 Omitted

Switch #10 Carling NBL Blank with L-00 Blank Legend

Switch #11 Carling NBL Blank with L-00 Blank Legend

Switch #12 Omitted.

R. C. Tronics Incorporated

2573 East Kercher Road
Goshen, Indiana 46528
Toll Free 1-866-457-7790

Phone 1-574-642-3857
Fax 1-574-642-3858
<http://www.rctronics.com>

RCT-01408-00015, Relays 4A, 4B, 5A & 5B

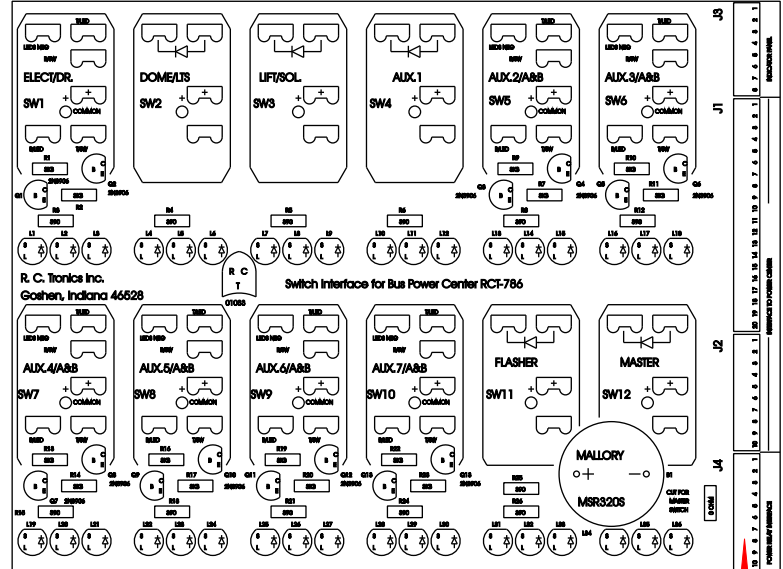
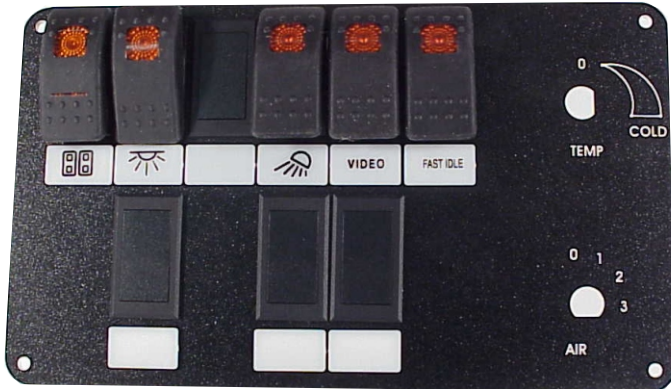

PCB-1083

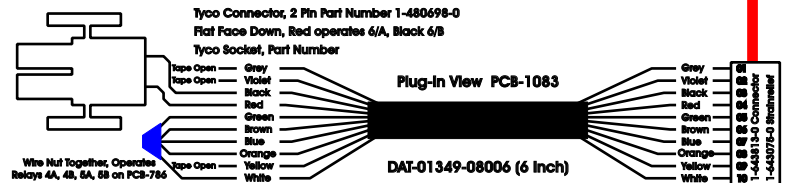

1- Faceplate, FAC-01241-00000, Material, Textures Coal Black / White, Part Number 842-422
1- S-01083

1 - 6 inch, Data Cable, DAT-01349-08006, connect to PCB-1083-J4

(Wire nut; green, brown, blue, orange & white. Operates relays 4A, 4B, 5A & 5B.)

Switch #01 Carling SB, Black (ON)-OFF-(ON), V8D1-WXXB-AFB00-000-XAM1 with Legend L-181, "Entry Door."

Switch #02 Carling SB, Black, ON-OFF, V1D11XOB-AEB00-000-XRC1 with Legend L-182, "Interior Light."

Switch #03 Carling NBL Blank with L-00 Blank Legend.

Switch #04 Carling SB, Black, ON-OFF, V1D11XOB-AEB00-000-XRC1 with Legend L-184, "Reading Light".

Switch #05 Carling SB, Black, ON-OFF, V1D11XOB-AEB00-000-XRC1 with Legend L-149, "Video".

Switch #06 Carling SB, Black, ON-OFF, V1D11XOB-AEB00-000-XRC1 with Legend L-6, "Fast Idle".

Switch #07 Omitted

Switch #08 Carling NBL Blank with L-00 Blank Legend.

Switch #09 Omitted

Switch #10 Carling NBL Blank with L-00 Blank Legend

Switch #11 Carling NBL Blank with L-00 Blank Legend

Switch #12 Omitted.

R. C. Tronics Incorporated

2573 East Kercher Road
Goshen, Indiana 46528
Toll Free 1-866-457-7790

Phone 1-574-642-3857
Fax 1-574-642-3858
<http://www.rctronics.com>

RCT-01408-00016, Relays 4A, 4B, 5A & 5B

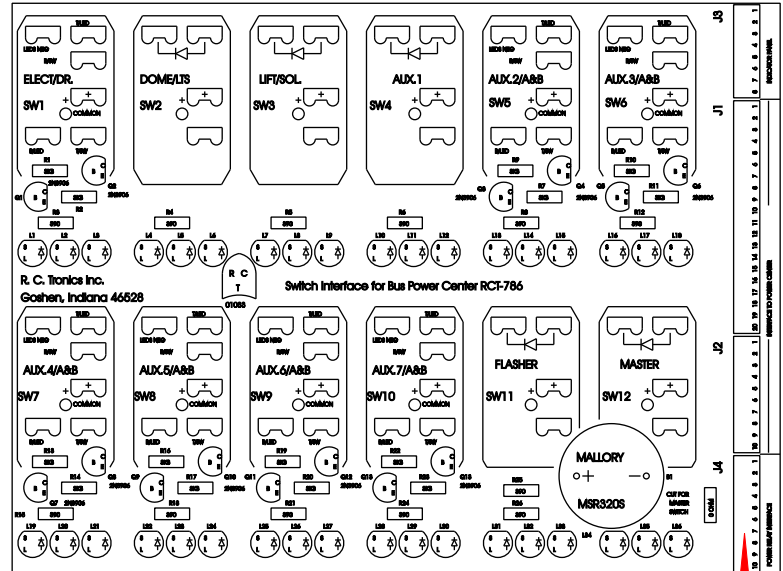
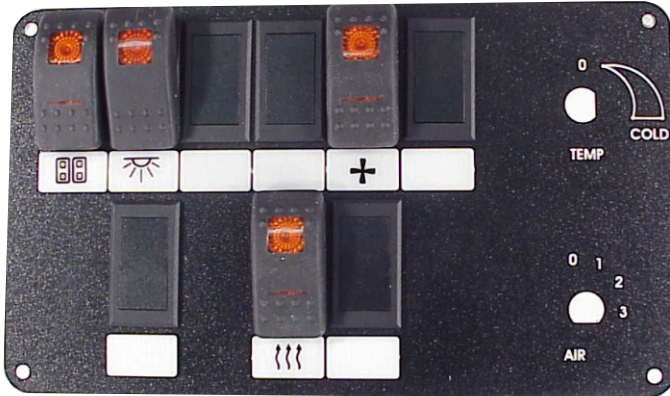

PCB-1083

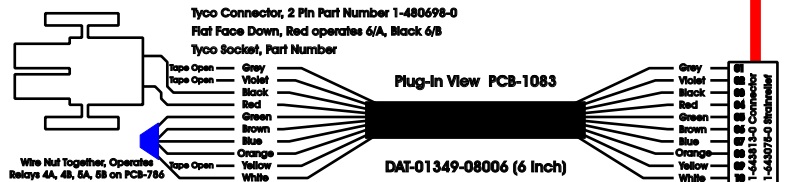

1- Faceplate, FAC-01241-00000, Material, Textures Coal Black / White, Part Number 842-422

1- S-01083

1 - 6 inch, Data Cable, DAT-01349-08006, connect to PCB-1083-J4

(Wire nut; green, brown, blue, orange & white. Operates relays 4A, 4B, 5A & 5B.)

Switch #01 Carling SB, Black (ON)-OFF-(ON), V8D1-WXXB-AFB00-000-XAM1 with Legend L-181, "Entry Door".

Switch #02 Carling SB, Black, ON-OFF, V1D11XOB-AEB00-000-XRC1 with Legend L-182, "Interior Light".

Switch #03 Carling NBL Blank with L-00 Blank Legend.

Switch #04 Carling NBL Blank with L-00 Blank Legend.

Switch #05 Carling SB, Black, ON-OFF-ON, V6D1WXXB-AFB00-000-XRC1 with Legend L-185, "Defroster Fan".

Switch #06 Carling NBL Blank with L-00 Blank Legend

Switch #07 Omitted

Switch #08 Carling NBL Blank with L-00 Blank Legend.

Switch #09 Omitted

Switch #10 Carling SB, Black, ON-OFF-ON, V6D1WXXB-AFB00-000-XRC1 with Legend L-187, "2nd Rear Heater".

Switch #11 Carling NBL Blank with L-00 Blank Legend

Switch #12 Omitted.

R. C. Tronics Incorporated

2573 East Kercher Road
Goshen, Indiana 46528
Toll Free 1-866-457-7790

Phone 1-574-642-3857
Fax 1-574-642-3858
<http://www.rctronics.com>

RCT-01408-00017, Relays 4A, 4B, 5A & 5B

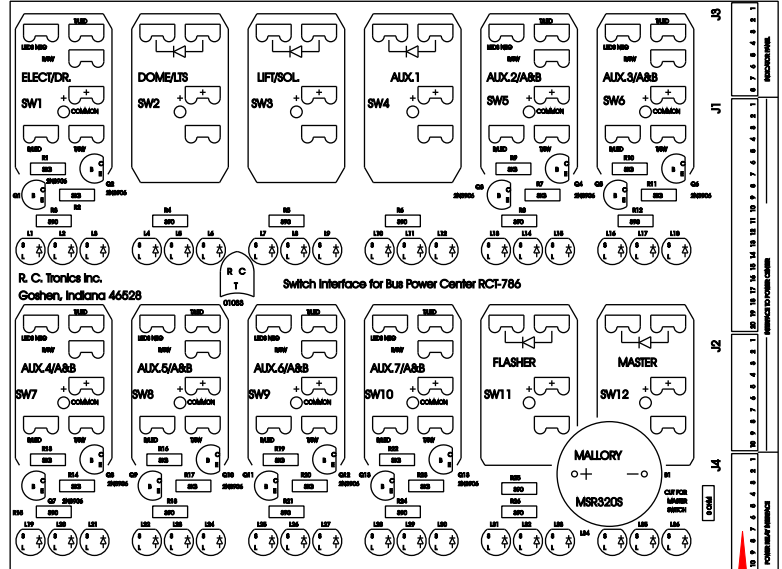
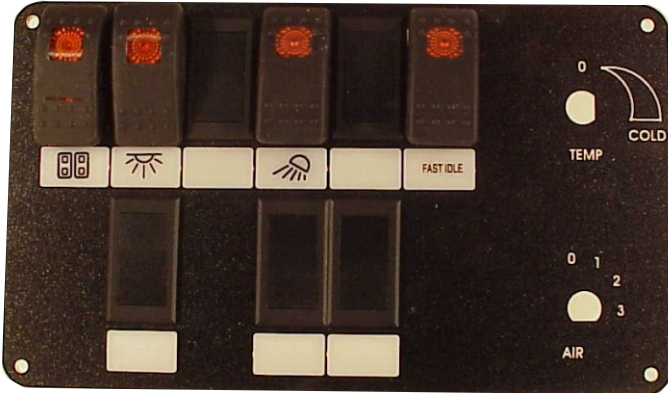

PCB-1083

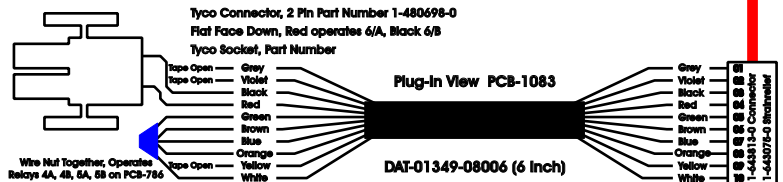

1- Faceplate, FAC-01408-00000, Material, Textures Coal Black / White, Part Number 842-422
1- S-01083

1 - 6 inch, Data Cable, DAT-01349-08006, connect to PCB-1083-J4

(Wire nut; green, brown, blue, orange & white. Operates relays 4A, 4B, 5A & 5B.)

Switch #01 Carling SB, Black (ON)-OFF-(ON), V8D1-WXXB-AFB00-000-XAM1 with Legend L-181, "Entry Door."

Switch #02 Carling SB, Black, ON-OFF, V1D11XOB-AEB00-000-XRC1 with Legend L-182, "Interior Light."

Switch #03 Carling NBL Blank with L-00 Blank Legend.

Switch #04 Carling SB, Black, ON-OFF, V1D11XOB-AEB00-000-XRC1 with Legend L-184, "Reading Light."

Switch #05 Carling NBL Blank with L-00 Blank Legend

Switch #06 Carling SB, Black, ON-OFF, V1D11XOB-AEB00-000-XRC1 with Legend L-6, "Fast Idle."

Switch #07 Omitted

Switch #08 Carling NBL Blank with L-00 Blank Legend.

Switch #09 Omitted

Switch #10 Carling NBL Blank with L-00 Blank Legend

Switch #11 Carling NBL Blank with L-00 Blank Legend

Switch #12 Omitted.

R. C. Tronics Incorporated

2573 East Kercher Road
Goshen, Indiana 46528
Toll Free 1-866-457-7790

Phone 1-574-642-3857
Fax 1-574-642-3858
<http://www.rctronics.com>

RCT-01408-00018, Relays 4A, 4B, 5A & 5B

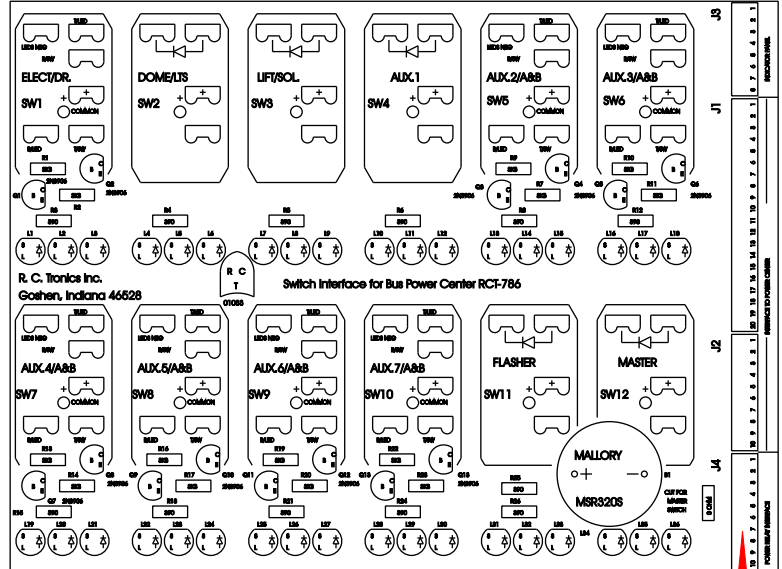
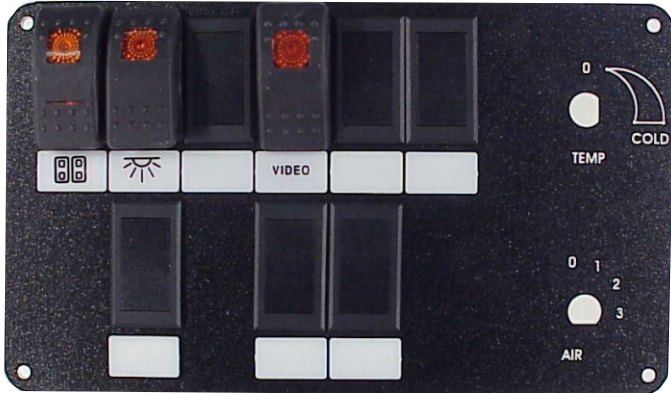

PCB-1083

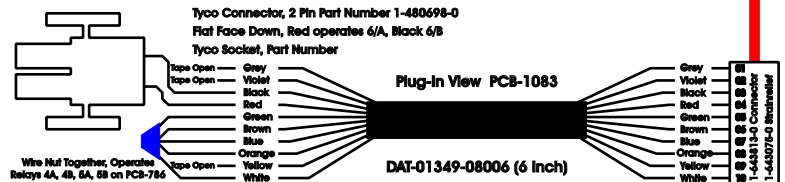

1- Faceplate, FAC-01408-00000, Material, Textures Coal Black / White, Part Number 842-422
1- S-01083

1 - 6 inch, Data Cable, DAT-01349-08006, connect to PCB-1083-J4

(Wire nut; green, brown, blue, orange & white. Operates relays 4A, 4B, 5A & 5B.)

Switch #01 Carling SB, Black (ON)-OFF-(ON), V8D1-WXXB-AFB00-000-XAM1 with Legend L-181, "Entry Door."

Switch #02 Carling SB, Black, ON-OFF, V1D11XOB-AEB00-000-XRC1 with Legend L-182, "Interior Light."

Switch #03 Carling NBL Blank with L-00 Blank Legend.

Switch #04 Carling SB, Black, ON-OFF, V1D11XOB-AEB00-000-XRC1 with Legend L-149, "Video."

Switch #05 Carling NBL Blank with L-00 Blank Legend.

Switch #06 Carling NBL Blank with L-00 Blank Legend.

Switch #07 Omitted

Switch #08 Carling NBL Blank with L-00 Blank Legend.

Switch #09 Omitted

Switch #10 Carling NBL Blank with L-00 Blank Legend.

Switch #11 Carling NBL Blank with L-00 Blank Legend.

Switch #12 Omitted.

R. C. Tronics Incorporated

2573 East Kercher Road
Goshen, Indiana 46528
Toll Free 1-866-457-7790

Phone 1-574-642-3857
Fax 1-574-642-3858
<http://www.rctronics.com>

RCT-01408-00019, Relays 4A, 4B, 5A & 5B

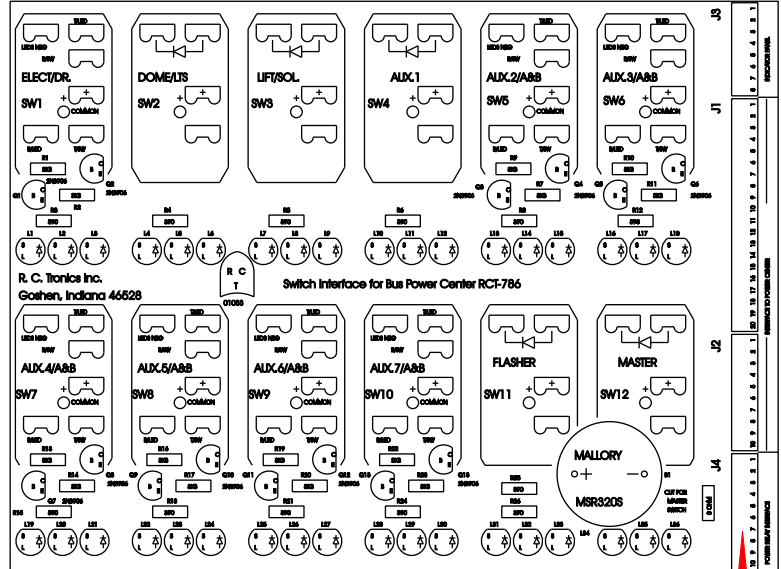
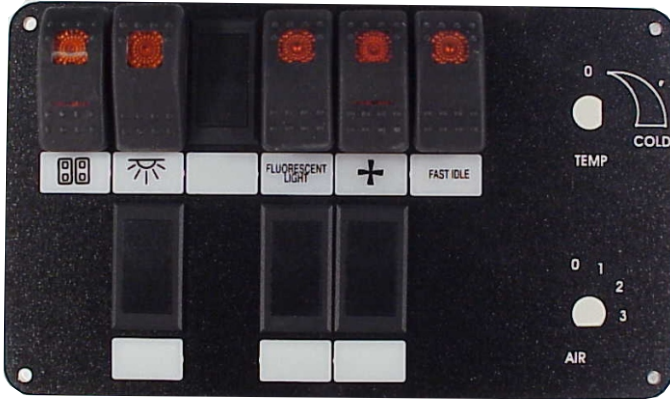

PCB-1083

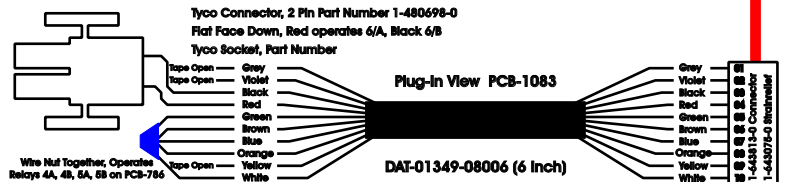

1- Faceplate, FAC-01408-00000, Material, Textures Coal Black / White, Part Number 842-422
1- S-01083

1 - 6 inch, Data Cable, DAT-01349-08006, connect to PCB-1083-J4

(Wire nut; green, brown, blue, orange & white. Operates relays 4A, 4B, 5A & 5B.)

- Switch #01 Carling SB, Black (ON)-OFF-(ON), V8D1-WXXB-AFB00-000-XAM1 with Legend L-181, "Entry Door".
- Switch #02 Carling SB, Black, ON-OFF, V1D11XOB-AEB00-000-XRC1 with Legend L-182, "Interior Light".
- Switch #03 Carling NBL Blank with L-00 Blank Legend.
- Switch #04 Carling SB, Black, ON-OFF, V1D11XOB-AEB00-000-XRC1 with Legend L-80, "Fluorescent Light".
- Switch #05 Carling SB, Black, ON-OFF-ON, V6D1WXXB-AFB00-000-XRC1 with Legend L-185, "Defroster Fan".
- Switch #06 Carling SB, Black, ON-OFF, V1D11XOB-AEB00-000-XRC1 with Legend L-6, "Fast Idle".
- Switch #07 Omitted
- Switch #08 Carling NBL Blank with L-00 Blank Legend.
- Switch #09 Omitted
- Switch #10 Carling NBL Blank with L-00 Blank Legend.
- Switch #11 Carling NBL Blank with L-00 Blank Legend
- Switch #12 Omitted.

R. C. Tronics Incorporated

2573 East Kercher Road
Goshen, Indiana 46528
Toll Free 1-866-457-7790

Phone 1-574-642-3857
Fax 1-574-642-3858
<http://www.rctronics.com>

RCT-01408-00020, Relays 4A, 4B, 5A & 5B

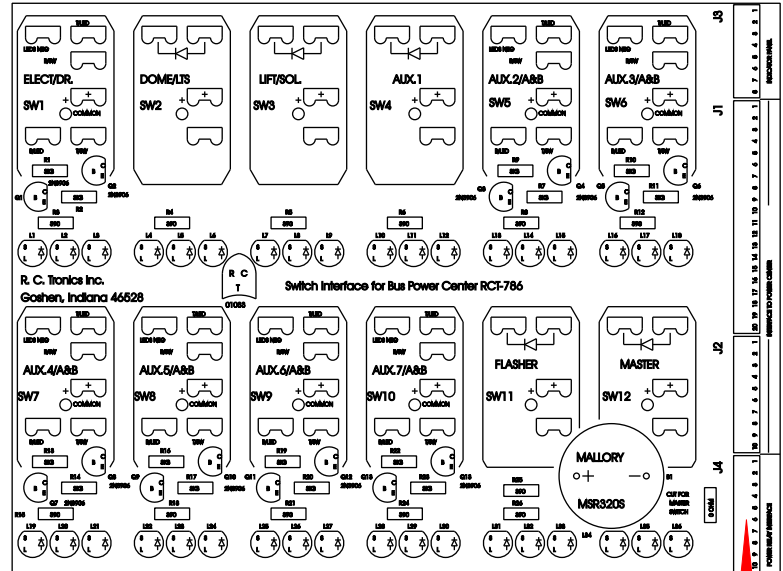
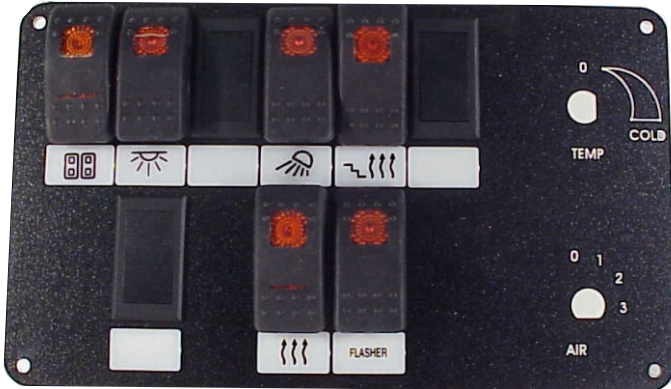

PCB-1083

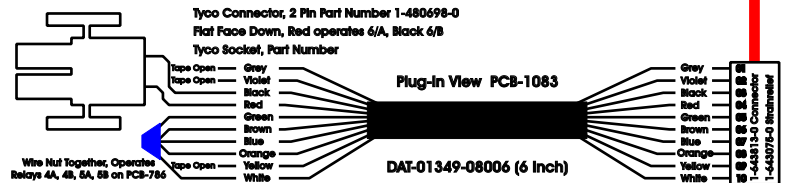

1- Faceplate, FAC-01408-00000, Material, Textures Coal Black / White, Part Number 842-422
1- S-01083

1 - 6 inch, Data Cable, DAT-01349-08006, connect to PCB-1083-J4

(Wire nut; green, brown, blue, orange & white. Operates relays 4A, 4B, 5A & 5B.)

Switch #01 Carling SB, Black (ON)-OFF-(ON), V8D1-WXXB-AFB00-000-XAM1 with Legend L-181, "Entry Door."

Switch #02 Carling SB, Black, ON-OFF, V1D11XOB-AEB00-000-XRC1 with Legend L-182, "Interior Light."

Switch #03 Carling NBL Blank with L-00 Blank Legend.

Switch #04 Carling SB, Black, ON-OFF, V1D11XOB-AEB00-000-XRC1 with Legend L-184 "Reading Lights".

Switch #05 Carling SB, ON-OFF, V1D11XOB-AEB00-000-XRC1 with Legend L-186 "Heated Step".

Switch #06 Carling NBL Blank with L-00 Blank Legend.

Switch #07 Omitted

Switch #08 Carling NBL Blank with L-00 Blank Legend.

Switch #09 Omitted

Switch #10 Carling SB, ON-OFF-ON, V6D1WXXB-AFB-00-000-XRC1 with Legend L-187 "2nd Heated Step".

Switch #11 Carling SB, ON-OFF, V1D11XOB-AEB00-000-XRC1 with Legend L-46 "Flasher".

Switch #12 Omitted.

R. C. Tronics Incorporated

2573 East Kercher Road
Goshen, Indiana 46528
Toll Free 1-866-457-7790

Phone 1-574-642-3857
Fax 1-574-642-3858
<http://www.rctronics.com>

RCT-01408-00021, Relays 4A, 4B, 5A & 5B

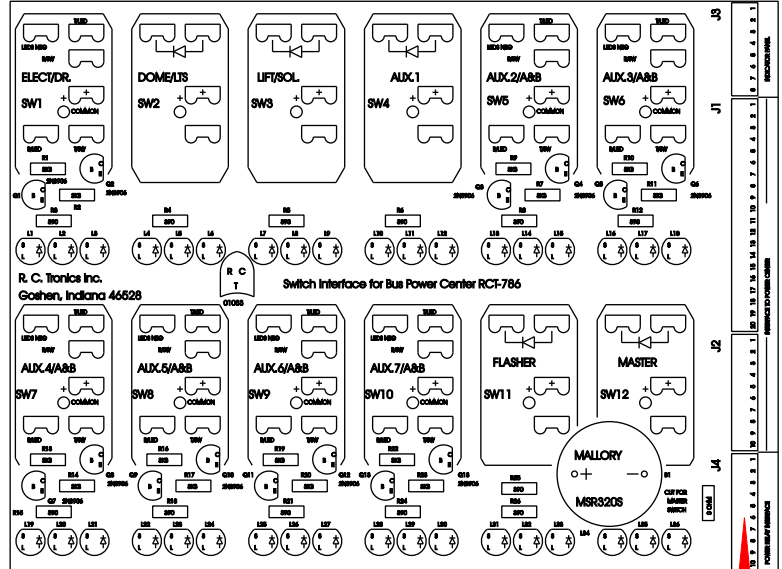
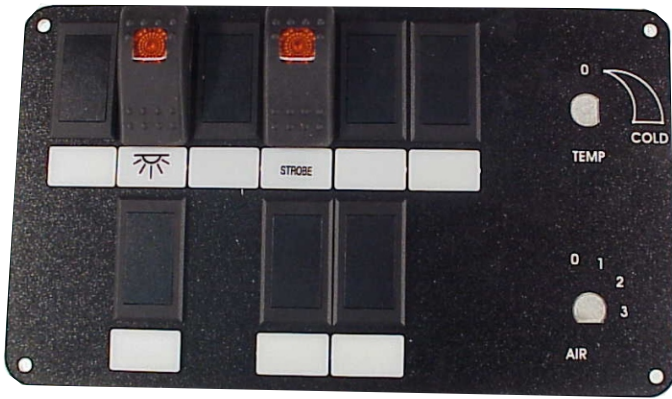

PCB-1083

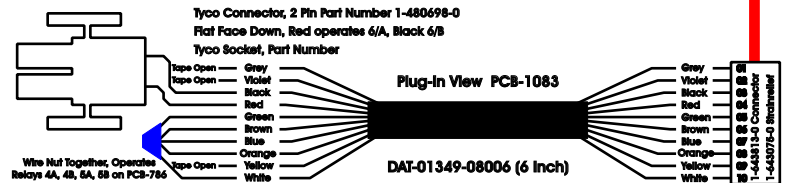

1- Faceplate, FAC-01241-00000, Material, Textures Coal Black / White, Part Number 842-422
1- S-01083

1 - 6 inch, Data Cable, DAT-01349-08006, connect to PCB-1083-J4

(Wire nut; green, brown, blue, orange & white. Operates relays 4A, 4B, 5A & 5B.)

Switch #01 Carling NBL Blank with L-00 Blank Legend

Switch #02 Carling SB, Black, ON-OFF, V1D11XOB-AEB00-000-XRC1 with Legend L-182, "Interior Light."

Switch #03 Carling NBL Blank with L-00 Blank Legend.

Switch #04 Carling SB, Black, ON-OFF, V1D11XOB-AEB00-000-XRC1 with Legend L-68 "Strobe".

Switch #05 Carling NBL Blank with L-00 Blank Legend

Switch #06 Carling NBL Blank with L-00 Blank Legend.

Switch #07 Omitted

Switch #08 Carling NBL Blank with L-00 Blank Legend.

Switch #09 Omitted

Switch #10 Carling NBL Blank with L-00 Blank Legend

Switch #11 Carling NBL Blank with L-00 Blank Legend

Switch #12 Omitted.

R.C. Electronics Incorporated

SPECIALIZING IN ELECTRONIC CONTROLS

2573 East Kercher Road

Phone 1-574-642-3857

Toll Free 1-866-457-7790

GOSHEN, IN 46528

Fax 1-574-642-3858

<http://www.rctronics.com>

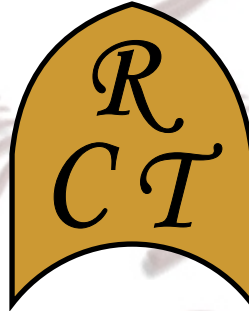

Custom Design of Electronic Controls

Speciality Vehicles

Fire Apparatus Systems

Police Vehicle Systems

Transit Bus Systems

Ambulance Systems

Printed Circuit Board Layout

Computer Generated Artwork

FR-4 PCB Material

Double-Sided Plated-Thru Hole

Complete Manufacturing Facility

New Era Wave Soldering Machine

Technical Devices PCB Cleaner

Automated PCB Insertion Equipment

Universal Laser System, Custom Faceplates

K .F. Hot Stamp Machine

[Permitt us to solve your Electrical / Electronic Control needs.](#)